

---

# Project Management

Project Management looks at how to manage projects. A project is an activity that has

- A start date
- An end date, and
- A specific outcome or deliverable

Some things are *not* projects:

- Reading your emails is not a project. It has no start date, no end date, and no specific deliverable
- Your ECE 401 term project *is* a project: it has all three of these.

Sometimes, project management isn't necessary: if a project is small enough or you have enough experience, you can simply start the design process right away. However, when dealing with a project which is

- Complex.
- Large in scope,
- With a large number of people, and
- Which has a hard deadline for completion,

a little organization up front helps to increase the odds of the project being successful. That's the goal of project management.

Project management isn't easy. People make careers out of being good at project management. You can get a degree in project management (called a MBA or Masters of Business Administration). Have respect for MBA's - they're really useful.

For example, some projects where project management was vital are:

- The James Webb Space Telescope had over 1200 scientists, engineers, and technicians from 14 countries and 27 states working on it.,
- The F35 Fighter has over 125,000 people in 46 states working on it
- TerraPower has over 600 employees designing the next generation Thorium fueled nuclear reactors.

Projects of this size and complexity take considerable organization to complete successfully.



Some of the scientists, engineers, and technicians involved with the James Webb Space Telescope

In Senior Design II and III, you won't be given a project anywhere near as complicated as these. However, you will be given

- A fairly complex project,
- With a team of three people,
- With a hard deadline: the end of the second semester.

It really pays off to spend some time at the start of ECE 403 to get the project organized. We'll be doing this in Senior Design I with a smaller, simpler project. Hopefully when you get to ECE 403, the ideas behind project management make more sense and can be applied.

## Project Life Cycle

Starting out, any given project usually goes through the following stages:

- **Initiation:** Where you start the project. In companies, this is usually at the start of the fiscal year when money is allocated to the project.
- **Planning:** When the project manager defines the scope of the project, the time allocated to it, and the budget to complete the project. This also includes the organization of the project.
- **Executing:** Doing the work
- **Monitor and Control:** Feedback during execution to make sure the project remains on track.
- **Closing:** Finishing the paperwork and documentation, closing the accounts, releasing personnel.

This doesn't have to be sequential: the middle three (planning / executing / monitoring) can be repeated over and over as often as needed to get the project right.

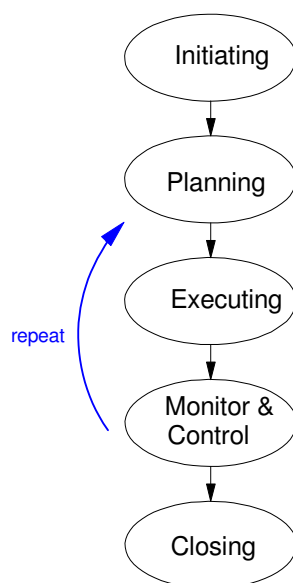

Stages in a project life cycle

The project manager (or project management) seeks to complete these tasks within the constraints of

- **Scope:** What the project is and what it isn't,
- **Time:** The time allocated to the project (start and end date), and
- **Cost:** How much money and resources are allocated to the project

## Constraints

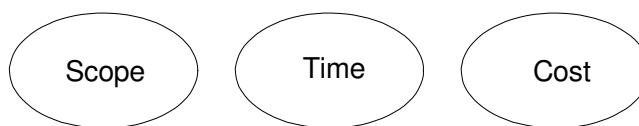

Triple Constraints: Define the scope of the project, the time allocated, and the budget allocated.

Part of what a project manager does is make sure the time and budget allocated are sufficient for the scope of the project. He/she also protects the project against project creep: others trying to increase or change the scope of the project without allocating any more time or budget.

## Project Charter

One way to prevent project creep is to start with the *project charter*. This is a document which specifies

- What are the deliverables for the project
- What are the key elements for the project
- How much time is allocated for the project, and
- What's the budget

The *project charter* is the most important document in the project. When someone joins the team, the *project charter* helps him/her know what the project is all about. When a manager tries to change the scope of the project (project creep), the *project charter* defines what the project is, what it isn't, and whether this new mission is or isn't within the scope of this project.

As a note - everyone at your company is part of the same team. If something important comes up and it needs to be added to a project, you'd like to say *yes, we can do that*. However, given a limited time and budget, there's only so much you can do. If the new task is really that important and it significantly changes the project, you might need more time, people, and resources. The *project charter* helps the project manager make that argument.

## Work Breakdown Structure

Once the project is defined, the next task is to split the project into smaller tasks - sort of a divide and conquer technique. Once the tasks are small enough, you can start knocking them off one by one.

Level 1: The project as defined by the *project charter*.

Level 2: Split the project by department (engineering, marketing, production) or by functionality (user interface, sensors, filters, etc.)

Level 3: Specify the major parts of each part. For Senior Design, I like to think of this as the major technical challenges you need to solve in ECE 403 so that you'll have a working device at the end of ECE 405.

Level 4: Tasks. What are the tasks that need to be completed to solve each of the technical challenges defined in Level 3.

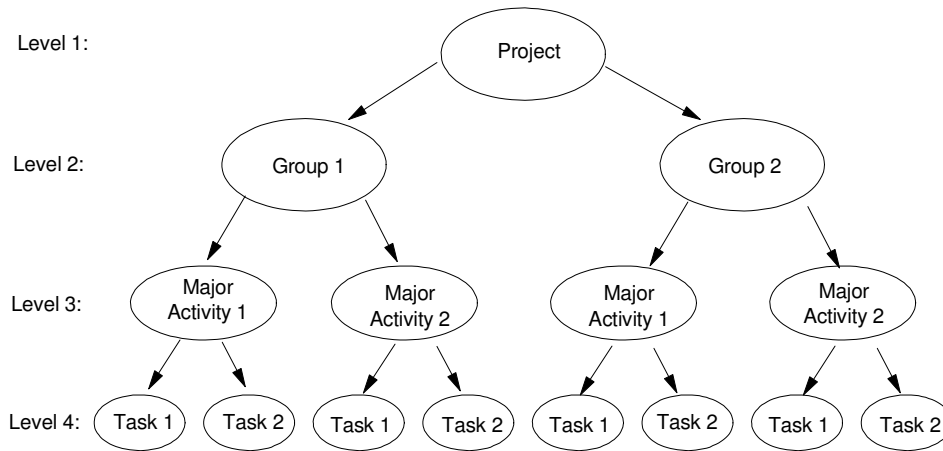

Use a divide and conquer approach to split a project into smaller sections, eventually defining the tasks that need to be completed to finish the project

### Gantt Charts

Gantt Charts help you plan out the semester

- What activities do you need to complete,
- How much time do you allocate for each activity, and
- When these activities are to take place.

Essentially, a Gantt Chart is a tabular form of each person's Work Breakdown Structure. For Design I, the Gantt chart is usually about the same for everyone: complete homework sets 1 though 8 over the 16 weeks of the semester:

Major Activity <i>homework assignments</i>	Week															
	1	2	3	4	5	6	7	8	9	10	11	12	13	14	15	16
1: Project Selection																
2: Work Breakdown Structure																
3: Schematics & Paper Design																
4: Simulation																
5: Breadboard																
6: PCB Layout																
7: PCB Test																
8: Sr Design Expo																

## Project Management Techniques

In terms of what project management is, there are about as many styles of project management as there are graduates with an MBA. Coursara, for example offers over 2700 different courses on project management. Four different version of Project Management are

- Critical Path
- Waterfall
- Agile
- Total Quality Management

### Waterfall

The idea behind *Waterfall* is

- A given project can usually be split into a set of tasks that need to be completed.
- One way to complete the overall project is to complete these tasks one at a time.
- The *waterfall* shows you the order in which these tasks will be completed.

Waterfall is very common and it's what we usually use in Senior Design. In both 401 and 403/405, a list of things that need to be completed by the end of the course is

- Requirements Capture: Define the inputs, outputs, and how they relate.
- Paper Design: Analysis and calculations for circuits and/or programs which meet these requirements.
- Simulation: Test your hardware design in simulation or test your software with test programs.
- Breadboard: If your design works in simulation, build it on a breadboard to get the schematics correct.
- PCB: Transfer your breadboard design to a printed circuit board.
- Testing: Check that final design meets the system requirements.
- Packaging: Place your final design in a package for delivery to your customer (ECE 405 only).

The is also the order which these tasks need to be done. A *waterfall* approach to project management would have you

- Complete task #1 (requirements) before you start with the paper design.
- Complete task #2 (paper design) before you start with simulation,
- etc.

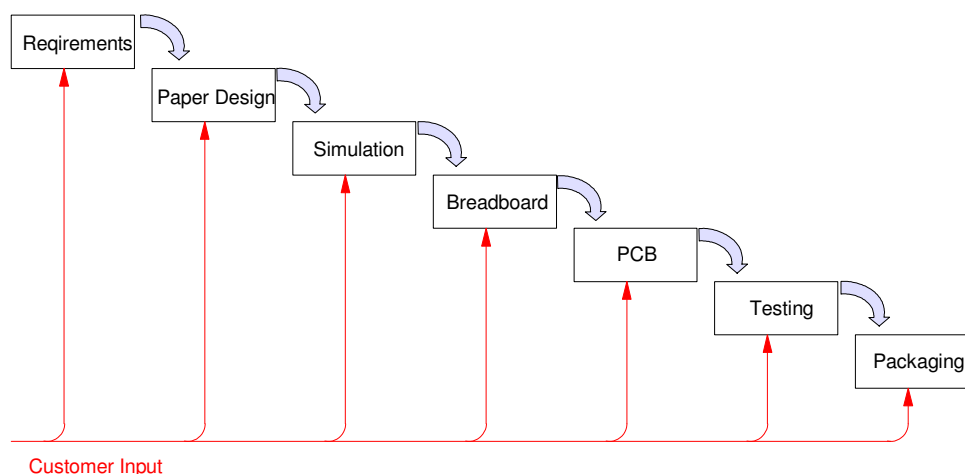

Waterfall: The project is divided in to smaller tasks.  
Each task needs to be completed before the next task is begun.

Waterfall projects can be very agile and responsive to customer input. There is nothing stopping you from having customer input and alterations to the design along the way. Often times, this is necessary: customers often times don't know what they want until they see it. As the customer sees your project progress, he/she may get a better understanding of what they really need and what can be delivered.

### Critical Path

The idea behind Critical Path is that

- Most projects can be broken down into smaller parts. To graduate from NDSU in Computer Engineering, for example, you need to take and complete forty courses.
- Some things have to be done sequentially. You can't shingle a roof until you have a roof. You can't take Calculus II until you complete Calculus I.
- If you lay out all of the tasks in the order of when they can be completed, you'll see the longest path from start to finish, This is the critical path.

For example, if you lay out all of the courses you need to take in Computer Engineering at NDSU in terms of prerequisites, the flow chart looks like the following. The longest path from start to finish is then evident: the shaded path that starts from Math 103 and ends with ECE 405. That is the critical path.

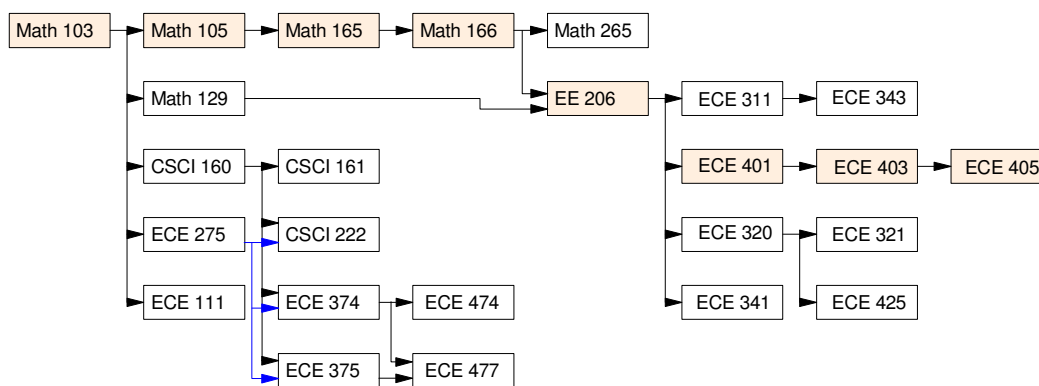

Courses Required to Graduate in Computer Engineering along with the critical path (highlighted)

What the critical path tells you is

- If you want to graduate in the minimum time possible, you *need* to be taking the next course in this sequence each semester. If you skip a semester, you postpone graduating.
- The other courses can be moved around to even out the workload each semester - providing you are abiding by the prerequisites.

The same holds in Senior Design. If you break your project down into smaller chunks then arrange these by the order they need to be completed, you'll see which activities form the critical path. At any given time, you need to be working on the next item in this path. If you don't, your end date will slip.

## Agile

Agile is a slightly different technique than Waterfall. With Agile, you have an iterative design with multiple sub-tasks. The idea is to

- Split the project into smaller tasks, then
- Go through the entire design sequence for each task, one by one (requirements, paper design, breadboard, PCB design, validation)

Essentially, the goal is to slap out a prototype quickly, then iterate on improving this prototype over and over.

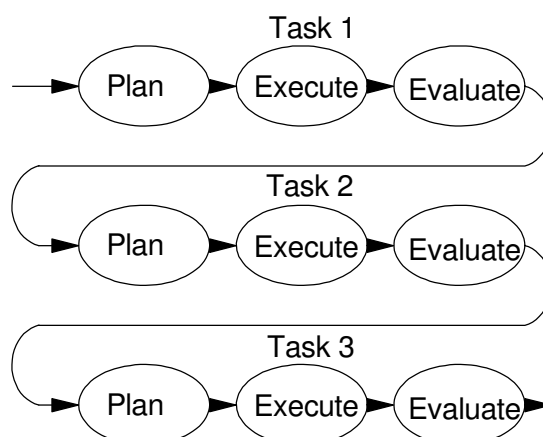

Agile: Go through the design cycle multiple times, improving the design each iteration.

For example, suppose you want to build a stoplight. One way to split up the tasks are

- Physical Design
- User Interface
- Traffic Sensors
- etc.

The first iteration might look at the user interface: design a cell phone app that shows you what the stoplight is doing and allowing you to adjust parameters. To get this to work, you could use dummy data. You then get feedback from everyone (customer, software, hardware) that this part of the design is acceptable.

Once done, you could start working on the physical stoplight - having the lights controlled as per the user interface design in step 1. Again, you go through the entire design process for this stage.

Once done, you could start working on the wireless interface - removing the wires in step #2. And so on.

---

## Total Quality Management (TQM)

One problem which is actually fairly common in industry comes from 'over the wall' design. For example, suppose Company A is trying to design and build a widget.

- The hardware group starts with the design. When done, it passes their final design over the wall to the software group.
- Software looks at the hardware design and it doesn't really work for them. So, software redesigns the hardware and then writes the corresponding software. Once done, they pass the final design over the wall to manufacturing.
- Manufacturing looks at the design and it really doesn't work for them either. So, manufacturing redesigns the hardware and software so that the product can be built.

While this approach works, it is expensive both in terms of time to complete and manpower resources required.

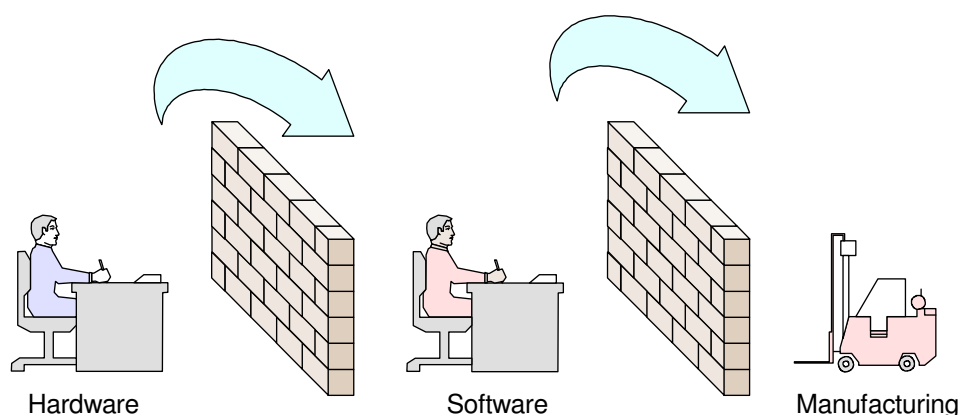

"Over the Wall" design: Once one group finishes their design, it's tossed "over the wall" to the next group, never to be seen again.

The idea behind TQM is to get the design right, right from the start. To do that, you need to have an initial design meeting with everyone right from the start. Once you hash out a framework that hardware, software, and manufacturing can live with, *then* you start the design process.

The hope is that you won't have to redesign the widget each step of the way, saving both time and money.



# Work Breakdown Structure

A typical Work Breakdown Structure for Senior Design is:

- Level 1: Your project for ECE 401
- Level 2: Project Breakdown. Projects in ECE 401 are simple enough that no further breakdown is needed.
- Level 3: Major Activities. These are the homework sets in ECE 401
- Level 4: Tasks: What you need to do to complete each homework set

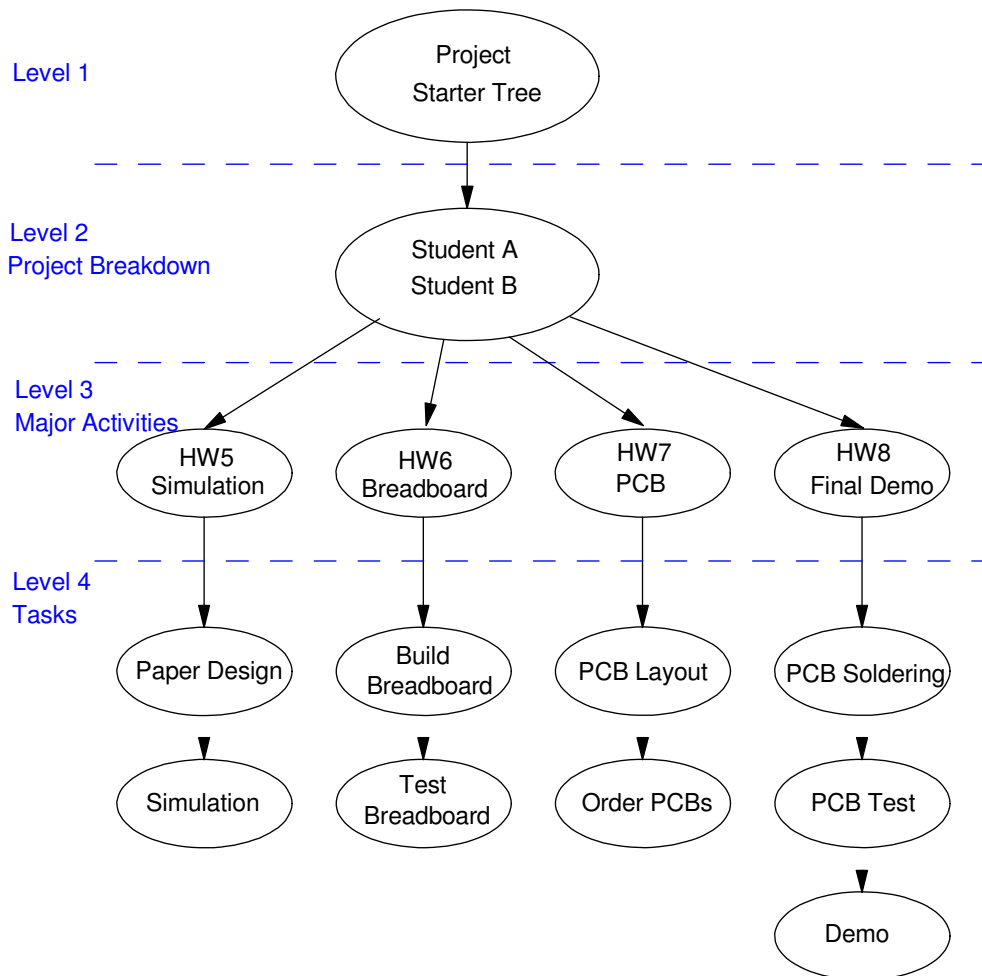

---

### Level 3: Major Activities

Level 3 breaks your project down into a list of major activities. Essentially, these are the homework sets in ECE 401:

- HW5: Simulation
- HW6: Breadboard
- HW7 PCB
- HW8 Final Report

### Level 4: Tasks (To-Do list)

Once you've identified the major activities, generate a list of tasks that need to be completed in ECE 401. This might include:

HW5: Simulation

- Design a circuit on paper to meet your requirements.
- Calculate the values of resistors and capacitors
- Simulate this in CircuitLab to verify your calculations.

HW6: Breadboard

- Next, build your circuit on a breadboard
- Measure the voltages (and currents?) to verify your circuit works correctly.
- Modify if needed to meet your requirements.
- Update schematics with the correct values and pin-outs.

HW7: PCB

- Transfer your schematics to Fusion360
- Lay out a PCB on Fusion360
- Send Gerber files to the instructors for ordering

HW8: Final Report

- When PCBs arrive, solder components onto PCB
- Measure the voltages to verify your PCB works like your breadboard and your simulations
- Demonstrate your working PCBs (one per student)
- Create a poster for the Design Expo
- Update OneNote if necessary

---

## Design Notebooks & OneNote

In Senior Design I, II, and III, design notebooks are required for documenting your work. This lecture looks at

- What a design notebook is
- How these notebooks are used when filing for a patent, and
- The use of MicroSoft OneNote as a design notebook

### What is a Design Notebook?

Design Notebooks are essentially your diary: that is where you keep all of your records of what your ideas, how you tested them, and what the results were. Design notebooks are also very common and very old: Leonardo Da-Vinci, for example, kept extensive notes on his work

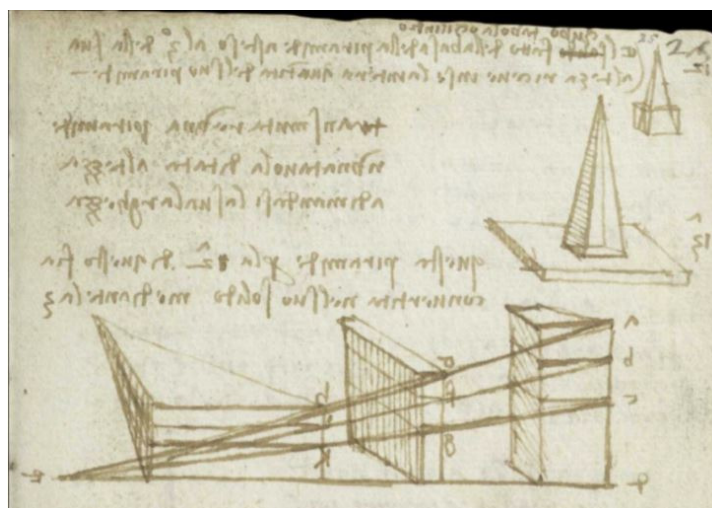

Page from one of Leonardo Da-Vinci's design notebooks<sup>1</sup>

Design Notebooks serve several purposes:

- They help you organize your thoughts. My advisor back at Ohio State use to say "If you're stuck, write up what you have." The process of writing forces you to organize your thoughts and your work. In doing so, holes and avenues you missed become more apparent.
- They serve as a reminder. If you ever want to go back and refresh your memory on what you were thinking, what you tried, and what the results were, all of that information is in your design notebook.
- Design Notebooks help the engineers who pick up where you left off when you get promoted. Often times, the design notebook is all that's available to help get your replacement up to speed in terms of what you did, what worked, and what didn't.
- Design Notebooks can also be used in the patent process

---

<sup>1</sup> <https://www.openculture.com/2018/08/leonardo-da-vincis-earliest-notebooks-now-digitized-and-made-free-online.html>

---

## Patent Law - What is a Patent?

From Wikipedia:

*A patent is a type of intellectual property that gives the owner the legal right to exclude others from making, using, or selling an invention for a limited period of time in exchange for publishing and enabling disclosure of the invention.*

In the United States, patents are issued by the United States Patent and Trademark office (USPTO). Patents are used in industry to prevent competitors from stealing their ideas and designs. Note that patents do not allow you to making, using, or selling an invention - they only block others from doing so. This is intentional: if identical patents are issued to two different parties, there is no conflict as far as the USPTO office is concerned. The two patents simply block each party from making use of the patent. It's up to them to negotiate who is allowed to use the patented item - and the USPTO is not involved in these negotiations.

The USPTO actually has a very friendly, easy to use web site. On that site, you can search for patents fairly easily, free of charge.

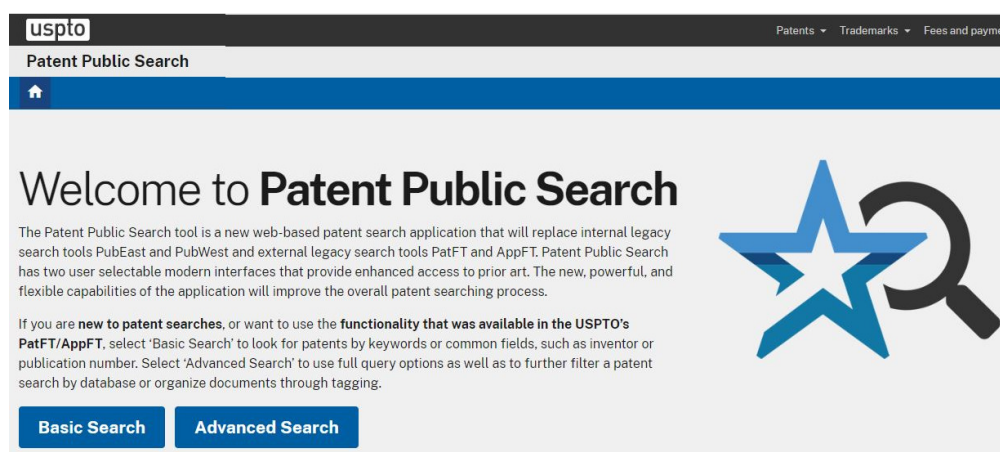

<https://ppubs.uspto.gov/pubwebapp/static/pages/landing.html>

If you have an idea and want to see if anyone else has thought of it, you can do a quick patent search on the idea. For example, if you search for "Talking Football", you'll get 3624 patents which contain the words "talking" and "football".

### Search results

Results for query "talking AND football"

Showing 1 to 50 of 3624 records 50 of 3624 records

Result #	Document/Patent number	Title	Inventor name	Publication date	Pages
1	US-11775052-B1 <a href="#">Preview</a> <a href="#">PDF</a>	Smart room system	Douglas; Robert Edwin et al.	2023-10-03	62
2	US-11771366-B2 <a href="#">Preview</a> <a href="#">PDF</a>	Method, apparatus, and system for radio based sleep tracking	Wu; Chenshu et al.	2023-10-03	52
3	US-11778138-B2 <a href="#">Preview</a> <a href="#">PDF</a>	System and methods providing supplemental content to internet-enabled devices synchronized with rendering of first content	Verna; Anthony F. et al.	2023-10-03	17
4	US-20230306218-A1 <a href="#">Preview</a> <a href="#">PDF</a>	METHOD FOR TRACEABILITY OF RAW MATERIALS, COMPONENTS, OBJECTS, AND PRODUCTS EXPOSED TO HARSH OPERATIONAL CONDITIONS IN INDUSTRY	Kayalar; Mete et al.	2023-09-28	38
5	US-20230308303-A1 <a href="#">Preview</a> <a href="#">PDF</a>	SYSTEMS, METHODS, AND APPARATUS FOR MEETING MANAGEMENT	Jorasch; James et al.	2023-09-28	407

3624 patents contain the words "talking" and "football"

You can also view the actual patent, either as a preview or you can see the entire patent. Selecting one at random as an example gives the patent for a football which has embedded electronics:

(19) **United States**  
 (12) **Patent Application Publication** (10) **Pub. No.: US 2023/0283110 A1**  
**BINDER** (43) **Pub. Date: Sep. 7, 2023**

---

(54) **DEVICE FOR DISPLAYING IN RESPONSE TO A SENSED MOTION**  
 (71) Applicant: **May Patents Ltd.**, Hod Hasharon (IL)  
 (72) Inventor: **Yehuda BINDER**, Ramat Gan (IL)  
 (21) Appl. No.: **18/196,109**  
 (22) Filed: **May 11, 2023**

*G01P 15/18* (2006.01)  
*A01K 15/02* (2006.01)  
*H02J 50/20* (2006.01)  
*H02J 50/90* (2006.01)  
*G01P 1/07* (2006.01)  
*H02J 7/00* (2006.01)

(52) **U.S. Cl.**  
 CPC ..... *H02J 50/10* (2016.02); *G10H 1/26* (2013.01); *A63B 21/0055* (2015.10); *A63H*

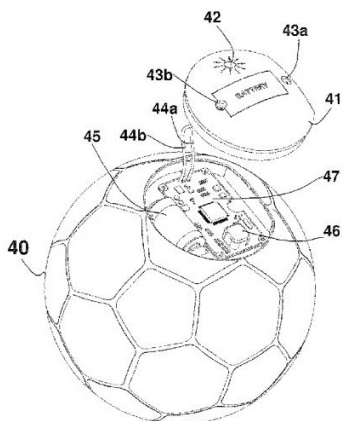

(57) **ABSTRACT**  
 A device includes a signaling means and a motion sensor, and logic for activating or controlling the signaling means in response to a sensed motion according to an embedded logic. The device may be used as a toy, and may be shaped like a play ball or as a handheld unit. It may be powered from a battery, either chargeable from an AC power source directly or contactlessly by using induction or by converting electrical energy from harvested kinetic energy. The embedded logic may activate or control the signaling means, predictably or randomly, in response to sensed acceleration magnitude or direction, such as sensing the crossing of a preset threshold or sensing the peak value. The visual means may be a numeric display for displaying a value associated with the count of the number of times the threshold has been exceeded or the peak magnitude of the acceleration sensed.

Typical Patent

The USPTO is very egalitarian: anyone can file for a patent or a trademark for not a lot of money. A trademark, for example, has a one-time filing fee of \$250. If granted, this trademark lasts for six years and can be renewed. A bulletproof patent that protects a corporation's intellectual property usually costs more - with most of that money going to patent attorneys. Still, an individual is more than welcome to submit a patent on their own.

In addition to granting patents, the patent office can reverse a patent, ruling it null and void. This is usually done if

- It can be shown that the invention was used prior to the patent, or
- The invention is obvious to an expert in the field.

A good example of this is the wheel: it's become sort of a fad for some people to try and sneak a patent for the wheel through the patent office. If disguised well enough, these patents can be approved. This happened in 2001 in Australia with the wheel called a "circular transportation fascillation device."<sup>2</sup> Technically, the owner of this patent can try to block anyone else from using a wheel unless they negotiate and pay a royalty for each wheel produced. However, if he/she ever tried to enforce their patent, the patent would be revoked since wheels were pretty clearly used prior to 2001.



The Wheel: Patented in 2001

## Patent Law - Pre 2019 (First to Bring to Practice)

In terms of who owns a patent, that depends. Prior to 2019, U.S. patents belonged to whoever was the first one to bring the invention to practice. This policy was very friendly to engineers: it made no difference who paid for and who filed the patent. The patent was going to be awarded to whoever was the first one to bring that invention to practice.

With this policy, engineering design notebooks were all important: they documented who first brought an invention to practice. This also made engineering design notebooks legal documents with several rules:

- Engineering design notebooks had to be hardbound so that pages could not be inserted.
- Each page had to be numbered consecutively (so you could tell if pages were added or removed).
- Entries into these notebooks had to be on consecutive pages: skipping pages was not allowed. (Doing so would allow someone to add information after the fact.)

<sup>2</sup> <https://www.newscientist.com/article/dn965-wheel-patented-in-australia/>

- Each page had to be dated, signed, and cosigned.
- All entries had to be in non-erasable pen.

All of these rules were designed to help the patent office (and sometimes courts) determine who was the first one to bring an invention to practice.

A good example of the importance of engineering design notebooks is the invention of the laser. The patent for the laser was awarded to Townes in 1959. For 18 years, Townes (or the company he worked for) owned the patent on the laser, and anyone wanting to use a laser had to get permission (i.e. pay royalties) from Townes (or his company).

In October 1977, however, the patent was reassigned to Gould due to his design notebooks from 1957. The fact that someone else paid for and filed the paperwork for a patent on the laser didn't matter. All that mattered was who was the first to bring the laser to practice, as evidenced by their design notebooks.<sup>3</sup>

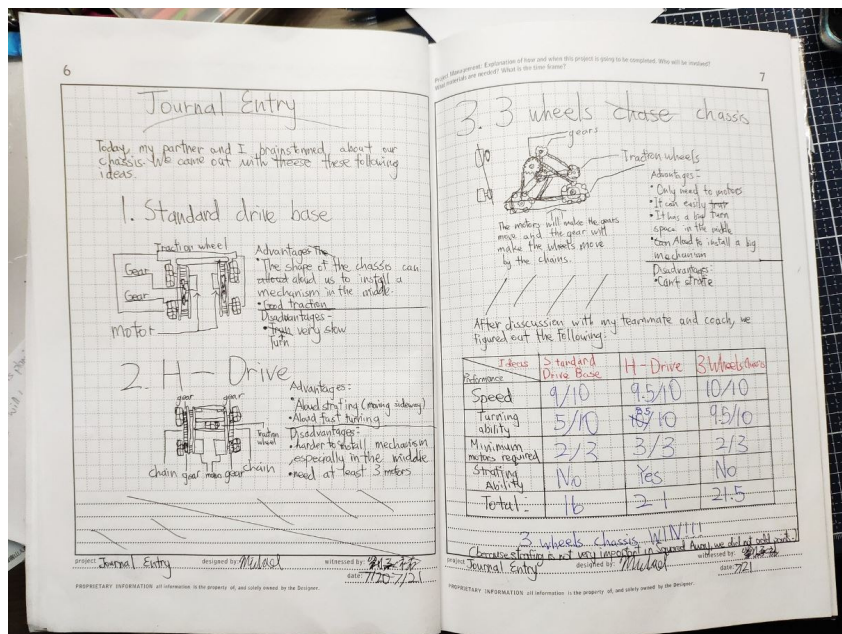

Engineering Design Notebooks: Pages are numbered, signed, dated, and written in ink

### Patent Law: Post 2019 (First to File)

While *first to derive to practice* is friendly to engineers, it's not friendly to companies. Companies want certainty: if they are awarded a patent, they want to be assured that their patent will not be reassigned in the future as happened with the laser.

<sup>3</sup> <https://www.electronicdesign.com/technologies/components/article/21795623/gordon-gould-the-l-ong-battle-for-the-laser-patent>

---

Likewise, due to pressure from industry, patent law changed in 2019 to *first to file*: patents belonged to the first person to file for the patent after deriving it to practice. From an engineer's standpoint, this means that your invention can be taken from you: whoever files for the patent first (after bringing it to practice) gets the patent.

With *first to file*, engineering design notebooks are no longer as important as they were. Likewise, they are no longer legal documents and the regulations about being hard-bound, numbered pages, signed, cosigned, etc. no longer apply. Engineering design notebooks are still diaries where engineers keep their notes, however.

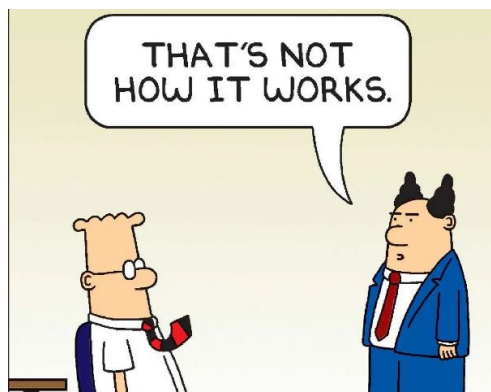

Patent Law Post 2019: First to File instead of First to Derive to Practice

## MicroSoft OneNote

This brings us to MicroSoft OneNote. Since engineering design notebooks are no longer legal documents, it's now OK to use electronic notebooks. Likewise, engineers have used PowerPoint, MS Word, MS Teams, and other programs for archiving their work.

MicroSoft OneNote is just another option in terms of recording and archiving your work electronically. The difference with OneNote is that it's designed

- To be easy to use
- To be versatile: you can include text, photos, excel files, videos
- To be collaborative: several people can be adding to a single OneNote file at the same time
- To be easy to read: your work can be organized in to sections and subsections (termed pages in OneNote).

The collaborative aspect is where OneNote really shines for senior design. You can have several students on your team, all working on different parts of the project, all able to add to their sections, all able to see what others are doing.

Being easy to read is also a big plus. As you work on your project, you may need to refer to what you did before (i.e. when working on homework #7 PCB Layout, you may want to refer back to homework #5 to get your schematic.) With OneNote, you can do that. When grading your homework, the grader can also see your previous work and how it leads up to the current homework assignment.

Basically, OneNote works really well for senior design.



## Suggested OneNote Organization for ECE 401

In OneNote,

- Your document is split into sections,
- Each section can contain one or more pages, and
- Each page can include text, photos, video, tables, etc.

To make your OneNote document easy to navigate, I suggest

- You make each section a homework assignment, and
- Pages within each section correspond to different parts of each homework assignment

You can then add content to each page as the semester moves along. (note: it's OK to go back and revise previous work in this class. If you find a mistake or a better way of doing something, go right ahead and revise your work. Sections are graded every two weeks - we'll also regrade sections where you lost points if you fix the mistakes.)

Section major activities	Page tasks	Content
HW1: Project Selection	Project Description	
	Contact Information	names, email, phone of students in your group
HW2: Work Breakdown Structure	Project Charter	Short Description Time Frame (16 weeks) Budget (\$50)
	Engineering Requirements	
	Gantt Chart	
HW3: Paper Design	Circuit Schematics	Circuit Schematic
	Calculations	Calculations for R's and C's Expected voltages and currents
HW4: Simulation	CircuitLab	CircuitLab schematic Simulation results
	Comparison vs. Calculations	Compare simulation to calculations
HW5: Breadboard	Schematic	
	Breadboard	Photo of breadboard Measurements Signals at Test Points
	Parts List	part, value, quantity
HW6: PCB Layout	PCB Layers	Top, Bottom, Top Silk Screen
	Gerber Files	
HW9: Final Report	PCB Testing	Photo of PCB Measurements Signals at Test Points
	Poster	

Suggested Layout for OneNote in ECE 401

---

**ECE 401: Homework for Week #2**

- Create a OneNote document (one document per group)
- Call your OneNote document ECE401\_XX\_YY
  - XX is the term (Fa24, etc)*
  - YY is your group number*
- Add sections for each major activity (homework sets)
- Share your OneNote document with each member of your group and your instructors