

# ECE 321 - Homework #5

DC Analysis of Transistor Amplifiers, 2-Ports, CE Amplifiers.

1) Determine the Q-point for the following transistor circuit. Assume C's are large and assume 3904 transistors:

- $V_{be} = 0.7V$
- $\beta = 200$

2) Modify this circuit so that

- The Q-point is stabilized for variations in  $\beta$ , and
- The Q-point is  $V_{ce} = 5.0V$

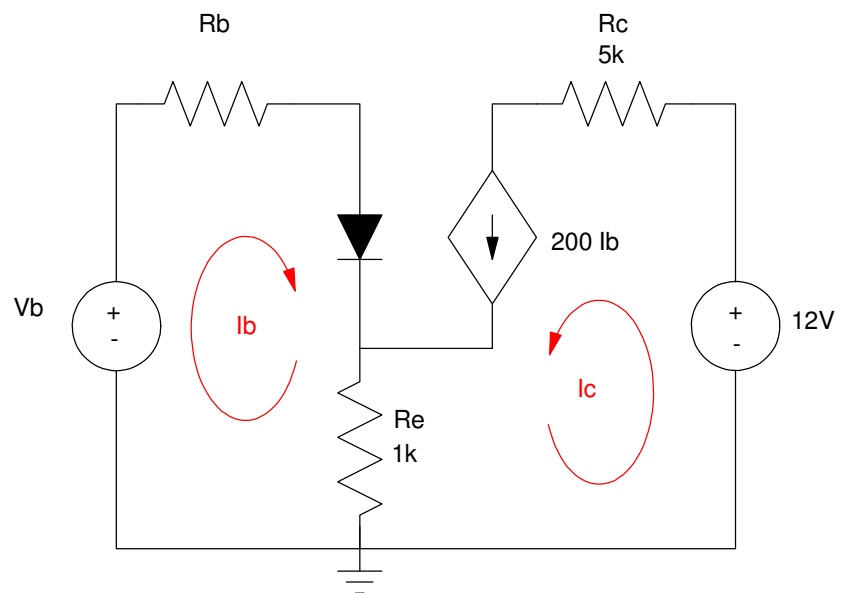
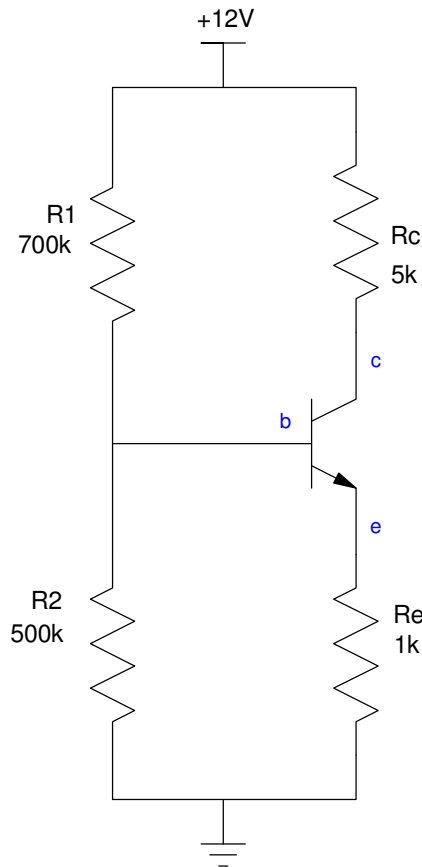

Problem #1 and #2

3) Draw the small-signal model for the circuit of problem #2 connected as a common emitter amplifier (below). From this, determine the 2-port model

4) Simulate this circuit in CircuitLab. Verify each of the 2-port parameters at 1kHz

- $R_{in}$
- $R_{out}$
- $A_o$

5) Remove  $C_e$ . Now draw the small-signal model for the circuit of problem #2. From this, determine the 2-port model for the Common Emitter amplifier

6) Simulate this circuit in CircuitLab. Verify each of the 2-port parameters at 1kHz

- $R_{in}$
- $R_{out}$
- $A_o$

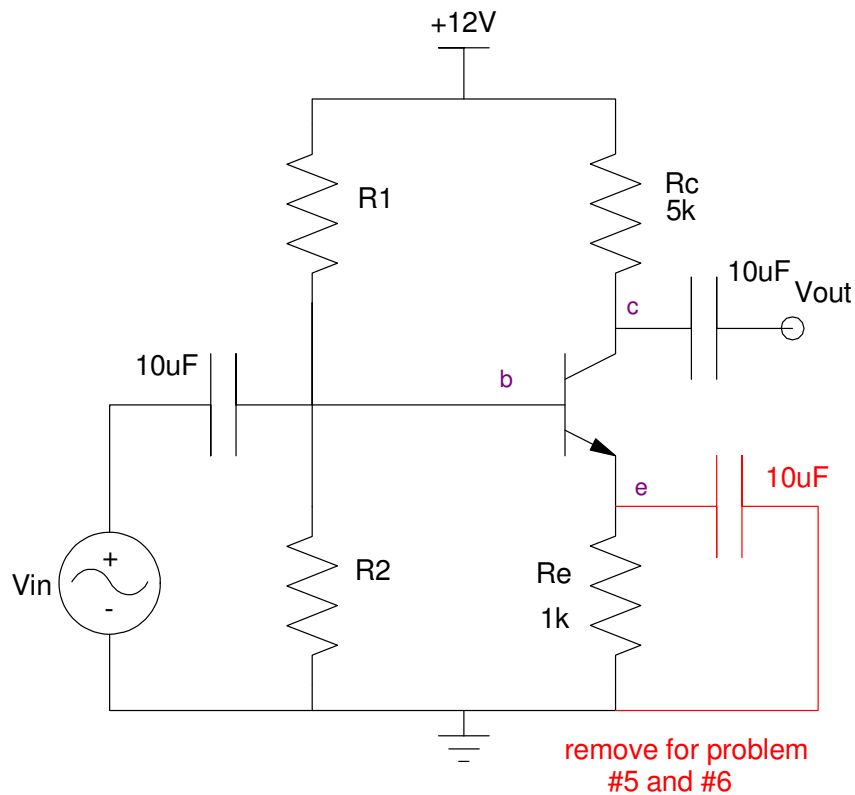

Problem 3 to 6. Use  $R_1$  and  $R_2$  from problem #2 (so that  $V_{ce} = 5V$ )